

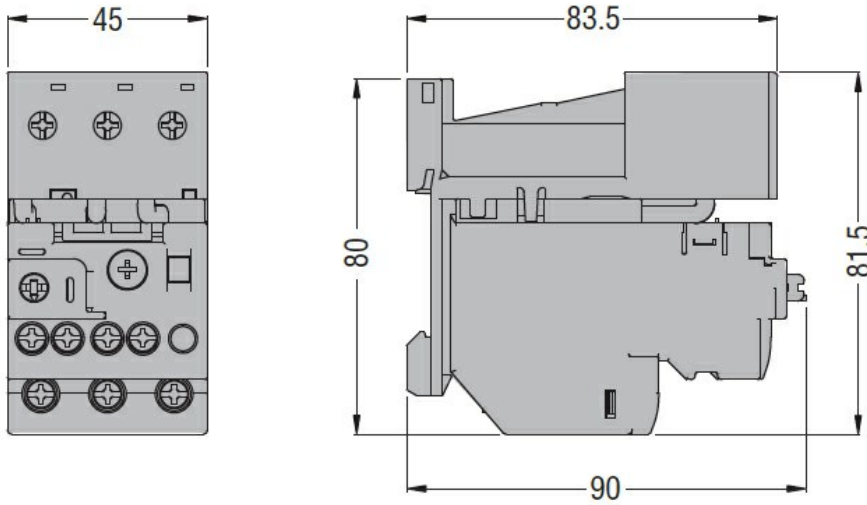

Product designation	RFE45		
Product type designation	Motor protection relay		
General characteristics			
Number of poles	Nr.	3	
Overvoltage category	III		
Pollution degree	3		
Frontal IP degree	IP20		
Type of release	Electronic thermal		
Protection fuse			
	gG (IEC)	A	20
	aM (IEC)	A	10
Phase failure detection	yes		
Reset mode	Manual or automatic		
Power circuit characteristics			
Rated insulation voltage U_i IEC/EN	V	1000	
Rated impulse withstand voltage U_{imp}	kV	6	
Rated operational voltage	V	690	
Operational frequency			
	min	Hz	50
	max	Hz	60
Operational current I_e			
	Operational current min	A	1.6
	Operational current max	A	8
Tripping class	5 - 10 - 20 - 30		
Test Button	yes		
Trip indicator	yes		
Terminals			
	type	screw and washer	
	screw	M4	
	width	mm	12
	tool	Phillips 2	
Tightening torque for terminals			
	min	Nm	3.1
	max	Nm	3.1
	min	lbin	2.3
	max	lbin	2.3
Conductor section			
	AWG/kcmil max	6	
Auxiliary circuit characteristics			
Auxiliary contacts	NO	Nr.	1

	NC	Nr.	1
Auxiliary Rated insulation voltage U_i IEC/EN		V	690
Auxiliary Rated impulse withstand voltage U_{imp}		kV	6
Auxiliary Rated operational voltage		V	690
Operating current AC15			
	24V	A	3
	120V	A	3
	240V	A	1.5
	380V	A	0.95
	480V	A	0.75
	500V	A	0.72
	600V	A	0.6
Operating current DC13			
	125V	A	0.11
	600V	A	0.22
IEC Conventional free air thermal current I_{th}		A	10
Terminals			
	Auxiliary circuit type		screw and washer
	Auxiliary circuit screw		M3,5
	Auxiliary circuit width	mm	7
	Auxiliary circuit tool		Phillips 2
Conductor section			
	Auxiliary circuit Flexible w/o lug max	mm ²	2.5
	Auxiliary circuit Flexible c/w lug max	mm ²	2.5
Tightening torque for terminals			
	Auxiliary circuit min	Nm	0.8
	Auxiliary circuit max	Nm	0.8
	Auxiliary circuit min	lbin	0.6
	Auxiliary circuit max	lbin	0.6
UL/CSA and IEC/EN 60947-5-1 designation			B600-R300
Ambient conditions			
Operating temperature			
	min	°C	-25
	max	°C	70
Storage temperature			
	min	°C	-55
	max	°C	80
Compensation temperature			
	min	°C	-25
	max	°C	70
Max altitude		m	3000
Mechanical features			
Operating position			
	normal allowable		Vertical plan ±30°
Fixing			Direct mounting on BF09... BF38...
Weight		g	195
UL technical data			
Full-load current (FLA) for three-phase AC motor			
	at 480V	A	8
	at 600V	A	8

Dimensions



Wiring diagrams

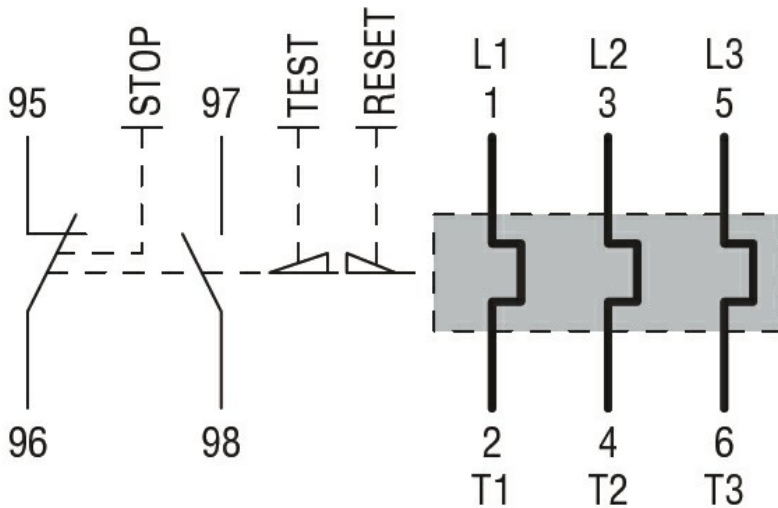

Certifications and compliance

Compliance

- CSA C22.2 n° 60947-1
- CSA C22.2 n° 60947-4-1
- IEC/EN 60947-1; IEC/EN 60947-4-1
- UL 60947-1
- UL 60947-4-1

Certifications

cULus

ETIM classification

ETIM 8.0

EC001080 -
Electronic
overload relay